



PF2105WV  
21.5 Inch Wi-Fi Digital Photo Frame  
User Manual

Version 1.0

# Table of Contents

---

1	INTRODUCTION.....	5
1.1	FEATURES.....	5
1.2	WHAT'S IN THE BOX.....	5
2	PRODUCT OVERVIEW.....	6
2.1	REMOTE CONTROL .....	6
2.2	OTHER PART AT BACK SIDE.....	7
2.3	INTERFACE AT RIGHT SIDE.....	7
2.4	INSTALLING OR REPLACING THE REMOTE-CONTROL BATTERY.....	8
3	IMPORTANT SAFETYINSTRUCTIONS.....	9
3.1	CLEANING THE DPF.....	9
4	GETTING STARTED.....	10
4.1	CONNECTING TO POWER.....	10
4.2	START UP THE DPF.....	10
4.2.1	CONNECT TO THE INTERNET VIA WI-FI.....	10
4.2.2	CHANGE SYSTEM LANGUAGE.....	11
4.2.3	CHANGE LOCAL DATE & TIME.....	12
4.2.4	CHANGE CITY.....	12
4.3	CONNECT WITH FRIENDS VIA VPHOTO APP.....	12
4.3.1	LOGIN VPHOTO.....	12
4.3.2	BIND YOUR FRAME.....	12
4.4	CONNECT WITH FRIENDS VIA EMAIL.....	13
5	USING WI-FI DIGITAL PHOTO FRAME.....	15
5.1	POST TO DIGITAL PHOTO FRAME VIA VPHOTO APP .....	15
5.2	POST TO DIGITAL PHOTO FRAME VIA EMAIL.....	15
5.3	MAIN MENU.....	16
5.4	PHOTO.....	16

5.4.1	START PHOTO SLIDESHOW.....	16
5.4.2	TURN ON/OFF BACKGROUND MUSIC.....	16
5.4.3	DELETE PHOTO.....	17
5.4.4	COPY PHOTO.....	17
5.4.5	ADD TO OR REMOVE FROM FAVORITES.....	17
5.4.6	ROTATE PHOTO.....	18
5.4.7	DISPLAY IN MULTI-WINDOWS.....	18
5.4.8	TURN ON/OFF CAPTION.....	18
5.4.9	ADJUST SLIDESHOW TIME INTERVAL.....	18
5.4.10	ADJUST SLIDESHOW TRANSITION EFFECT.....	18
5.5	VIDEO.....	19
5.5.1	PLAY VIDEO.....	19
5.5.2	DELETE VIDEO.....	19
5.5.3	COPY VIDEO.....	19
5.6	MUSIC.....	20
5.6.1	PLAY MUSIC.....	20
5.6.2	DELETE MUSIC.....	20
5.6.3	COPY MUSIC.....	20
5.7	CALENDAR.....	21
5.8	CLOCK.....	21
5.9	ALARM.....	21
5.10	WEATHER.....	21
5.11	SETTINGS.....	23
5.11.1	MY FRAME.....	23
5.11.2	ALBUM SETTINGS.....	23
5.11.3	WI-FI SETTINGS.....	25
5.11.4	FACTORY DATA RESET.....	26
5.11.5	HELP.....	26
5.11.6	ABOUT.....	26

5.11.7	ASSISTIVE TOUCH.....	26
5.12	CONNECT DPF WITH COMPUTER.....	28
6	PRIVACY.....	29
7	FREQUENTLY ASKED QUESTIONS (FAQ).....	30
8	CUSTOMER SUPPORT.....	31
9	PRODUCT SPECIFICATIONS.....	32
10	LIMITED WARRANTY.....	33

# 1 Introduction

Thank you for selecting the QPIX Wi-Fi Digital Photo Frame! Displaying your favorite picture is easy and fun.

## 1.1 Features

- 21.5-inch paper-feel HD IPS panel with 1920 \* 1080 pixels resolution, 16:9 aspect ratios.
- Built-In G-sensor supports landscape or portrait display model.
- Built-In Light Sensor: Eye protection screen.
- Smart IR remote control
- Dual Wi-Fi 2.4G/5G
- Easy to use: plug in USB stick or TF card and play.
- Supports most photo formats: JPG, JPEG, BMP, PNG and more.
- Supports most movie formats: MPEG-1, MPEG-2, MPEG-4 (AVI/Xvid), M-JPEG and more.
- Supports most audio formats: MP3, WMA, WAV and more.
- Supports photo with background music.
- Supports viewing pictures in thumbnail mode.
- Convenient features for daily life including weather, alarm, clock, calendar, video player and music player.
- Slots for TF memory card and USB memory stick.
- Loudspeaker.
- Auto power on and off
- 32 GB built-in memory

## 1.2 What's in the Box

- Digital Photo Frame (DPF)
- Remote-Control
- DC Power Adaptor
- Bracket
- Wall Mount Kit
- User Manual
- Warranty Card

## 2 Product Overview

### 2.1 Remote Control

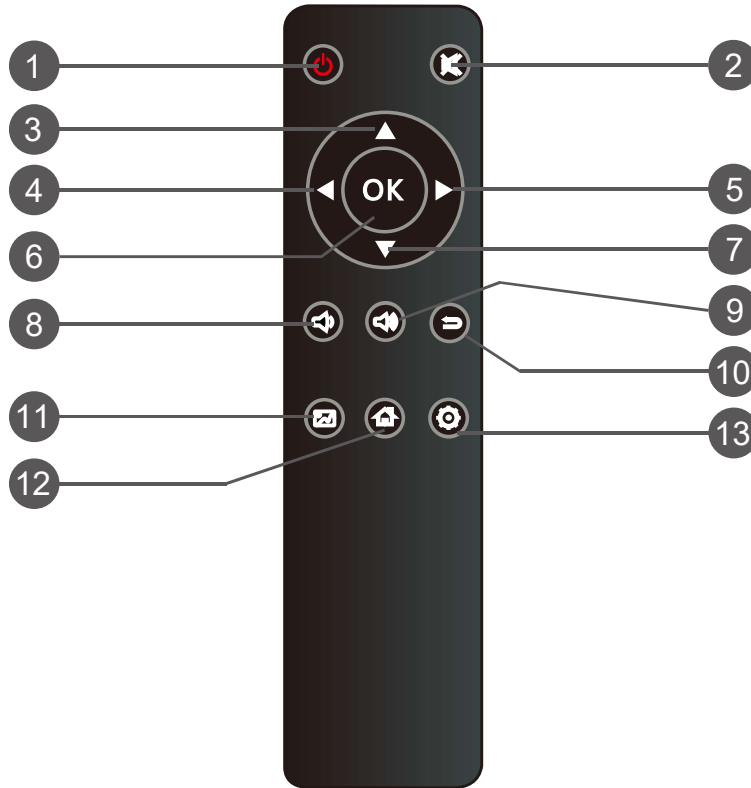

No.	Icon	Description
1		Power —Switch on off
2		Mute—Press mute button to silence the voice temporarily
3		Up key
4		Left key
5		Right key
6		Press it to confirm. Play/pause: In the playing mode, press this button to pause; repress it to play again
7		Down key
8		Turn down the volume
9		Turn up the volume
10		Return to previous page
11		Go to the photo gallery Interface
12		Go to the home screen
13		Go to the set up mode

## 2.2 Other Part at Back Side

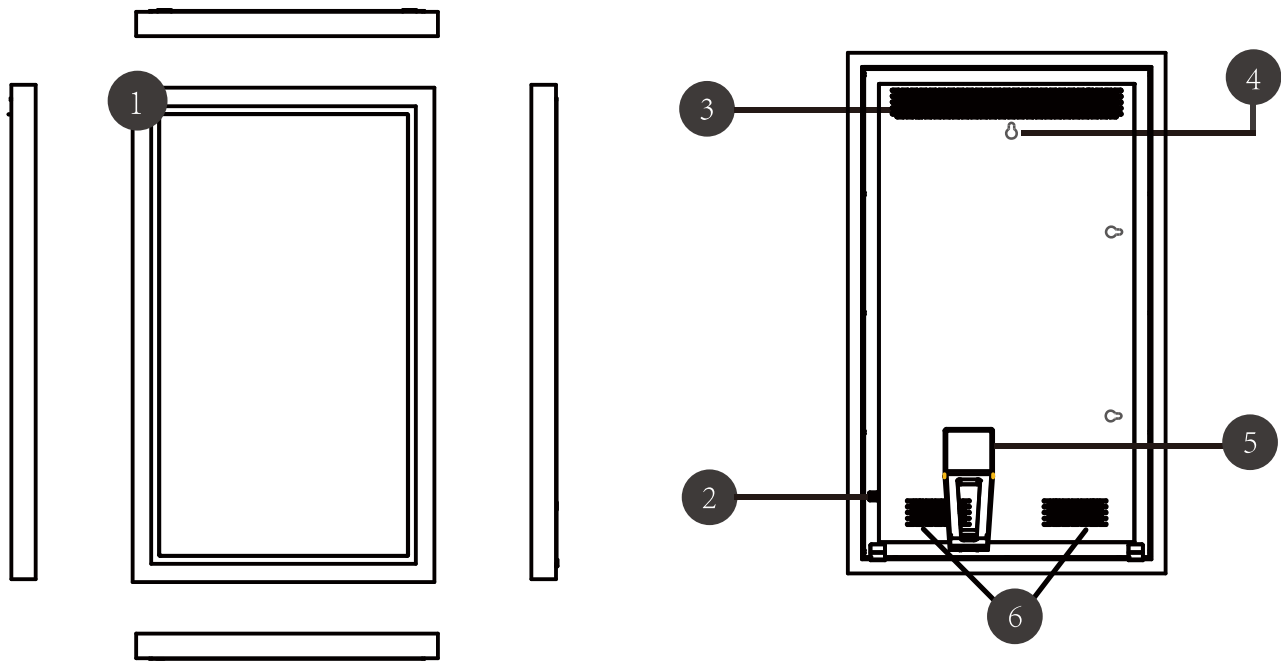

- 1 Frame
- 2 Power on/off Button
- 3 Vents
- 4 Wall Mount Hole
- 5 Bracket
- 5 Loudspeaker

## 2.3 Interface at Right Side

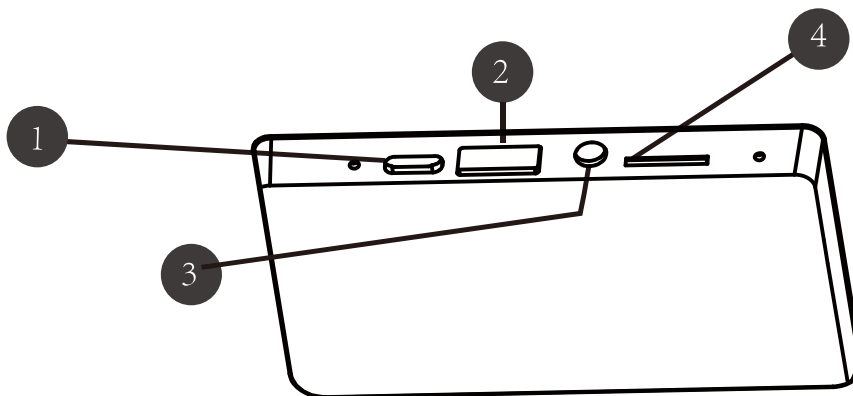

- 1 TYPE-C
- 2 USB
- 3 DC IN
- 4 TF Card Slot

## 2.4 Installing or Replacing the Remote-Control Battery

1) Please push and pull down the battery cover counterclockwise to open.



2) Please put 2 AAA batteries

3) Press and push the battery cover to close.

The PDF has a built-in remote-control sensor in the right corner of the digital photo frame. The working distance of the remote is approximately **10** meters or less.



## 3 Important Safety Instructions

Always follow these basic safety precautions when using your Digital Photo Frame (DPF). This will reduce the risk of fire, electric shock, and injury.

**Caution:** To reduce the risk of fire or shock hazard, do not expose this product to rain or moisture.

Do not remove the cover. There are no user-serviceable parts inside. Refer all servicing to qualified personnel.

- The DPF is for indoor use only.
- Unplug the DPF before performing care and maintenance.
- Do not block the ventilation holes on the back of the DPF at any time.
- Keep your DPF out of direct sunlight and heat sources.
- Route the power cable so that it is not likely to be walked on or pinched by items placed on or against it. Pay particular attention to the point where the cable attaches to the DPF.
- Only use the AC adapter included with the DPF. Using any other power adapter will void warranty.
- Unplug the power cord from the power outlet when the unit is not in use.
- Make sure the wall mount is strong enough to support the digital photo frame.

### 3.1 Cleaning the DPF

Please turn off the digital photo frame.

Treat the screen gently.

To clean fingerprints or dust from the LCD screen we recommend using a soft, non-abrasive cloth such as a camera lens cloth.



If you use a commercial LCD cleaning kit, do not apply the cleaning fluid directly to the LCD screen. Clean the LCD screen with the cleaning solution applied to the cleaning cloth. Clean the outer surface of the DPF with a soft cloth dampened with water.

## 4 Getting Started

If you are new to using Wi-Fi digital photo frame, please follow the instructions below or on-screen guide when powering it on for the first time.

Once you have set up your digital photo frame, you can start connecting it to your friends and family via VPhoto app or email.



### 4.1 Connecting to Power

- 1) Install the bracket or wall mount kit.
- 2) Remove the protective film/paper on the panel.
- 3) Place the DPF on a flat surface or on the wall firmly.
- 4) Plug the AC power adapter into the photo frames DC power jack and an electrical wall outlet.
- 5) Press the  button on the remote control.
- 6) Press the  and  keys at the same time for about 3~5 seconds to complete

### 4.2 Start up the DPF

After powering on the DPF for the first time, please connect to the Internet via WI-FI and change the system language, local time, city if necessary:

#### 4.2.1 Connect to the Internet via Wi-Fi



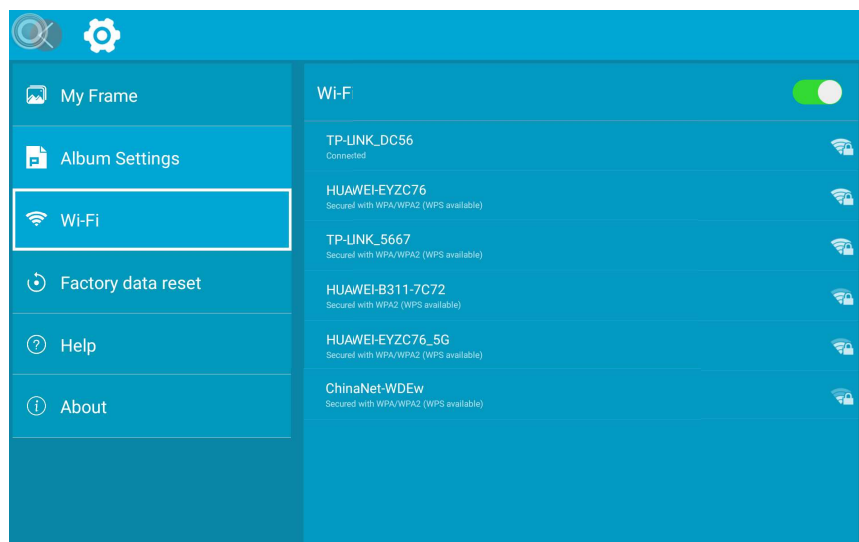

- 1) From the Main menu, select  or press  button of the remote control.
- 2) Select Wi-Fi .
- 3) Digital photo frame will scan available Wi-Fi networks and list the networks it finds. If the network was connected to the digital photo frame before, digital photo frame will connect to the network automatically.

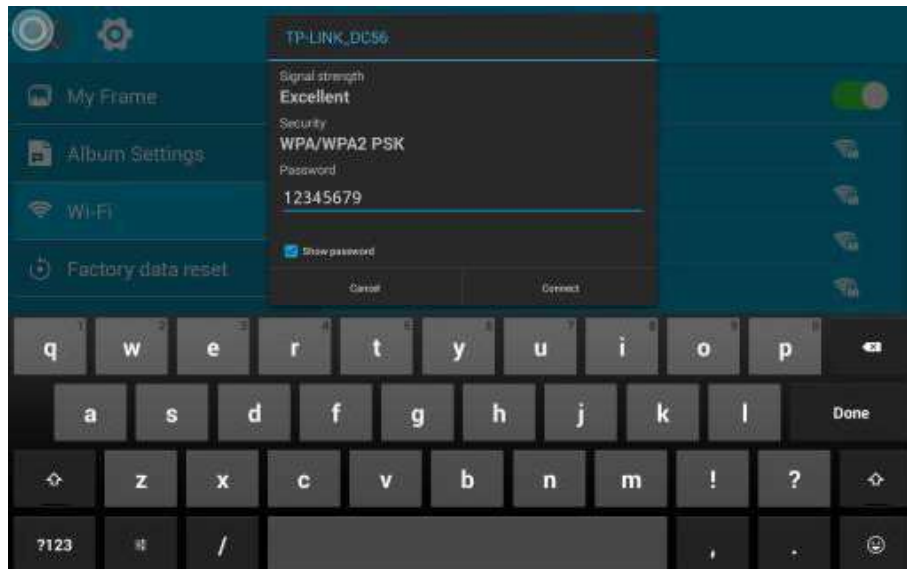





- 4) Select the network you want to connect to. Use the keyboard to enter the password. Check [Show password] to show password you entered.
- 5) Select [Connect] to connect Wi-Fi.



#### 4.2.2 Change System Language

- 1) From the Main menu, select  or press  button of the remote control.
- 2) Open Album Settings menu via select .
- 3) Open Language menu via select .
- 4) Scroll up or down and select the language.

### 4.2.3 Change Local Date & Time

- 1) From the Main menu, , select  or press  button of the remote control.
- 2) Open Album Settings menu via select .
- 3) Scroll up or down, open Date and Time via Select .
- 4) Select network-provided time or select time zone.

### 4.2.4 Change City

- 1) From the Main menu, open City menu via Select .
- 2) Enter City name and Select Search.
- 3) Select City via Select it.

## 4.3 Connect with Friends via VPhoto App

To send photos or video to your frame via smart device (phone, pad, or tablet), please use the VPhoto app for iOS or Android.

For Android, please search for "VPhoto" on Google Play.

For iOS, please search for "VPhoto" on the Apple Store.

### 4.3.1 Login VPhoto

Open VPhoto app, select Sign Up and fill in all the required information.

### 4.3.2 Bind Your Frame

Please confirm you have signed in VPhoto APP in smart device.

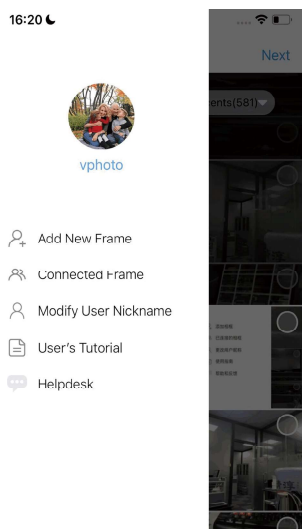

Select the "Next Step" on the top right to add your new device.

Or select the  icon on the top left, and then choose "Add New Frame"

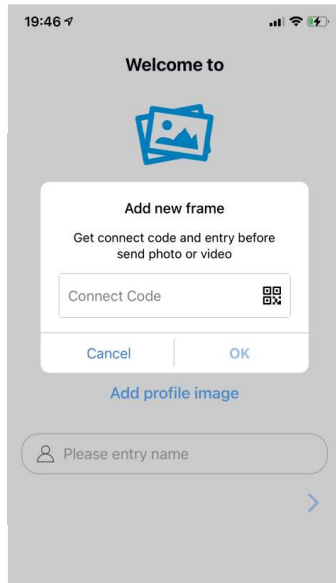

On your digital frame, select "Settings", then Select "My Frame" to find the connection code, which is valid for 12 hours.

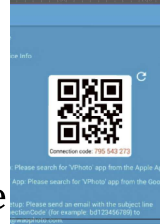

Add the connection code or use smart device to



scan the QR code on the digital photo frame.

After sending your binding request on the VPhoto app, you will receive a message "[Friend/Smart device name] has bind your device" on your digital frame.

### Tips:



- Connection code is a 9-digit series number which can be found on your digital photo frame via Select Settings , then Select My Frame .
- The connection code and QR code will be refreshed every 12 hours. Please connect to Wi-Fi network and select  to get the latest connection code.

## 4.4 Connect with Friends via Email

There are two methods to bind the digital photo frame with an email address.

#### 4.4.1 Via User Management

On the digital photo frame,

- 1) From the Main menu, open Settings menu via select .
- 2) Select My Frame .
- 3) Select User Management .
- 4) Add email address and then Select OK.

On the digital photo frame, select the user name under the users, you can view photos from this friend, remark name, delete the user.

## 5 Using Wi-Fi Digital Photo Frame

### 5.1 Post to Digital Photo Frame via VPhoto App

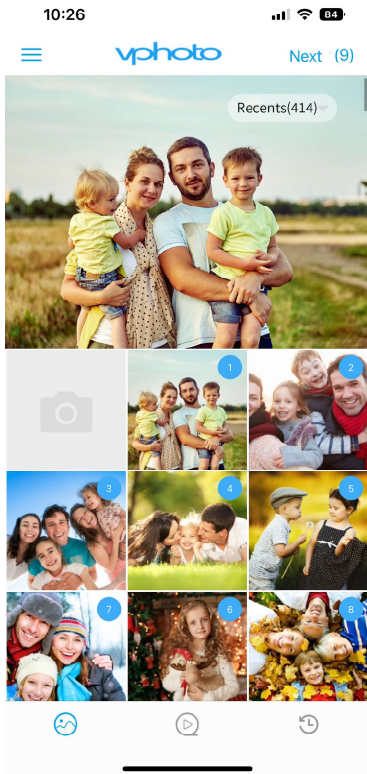

- 1) Enter the VPhoto app.
- 2) Choose the picture or video you want to post.
- 3) Select [Next Step] on the top right.
- 4) Choose a device then Select ➤ to send.

A pop-up message [Successful] will show on smart device.

You can Select [Continue to send] to send other photos or videos if you want.

### 5.2 Post to Digital Photo Frame via Email

After the mail address is bound to the digital photo frame, please send photos or videos as attachments to [1ABCDE@waophoto.com](mailto:1ABCDE@waophoto.com). Please replace *1ABCDE* with the **unique** mailbox ID of your digital photo frame which can be found under My Frame settings.

Despite there is no limit of photos and videos, please do not send too big files considering fair usage of the service.

### 5.3 Main Menu

After turning on digital photo frame, main menu will appear as below,

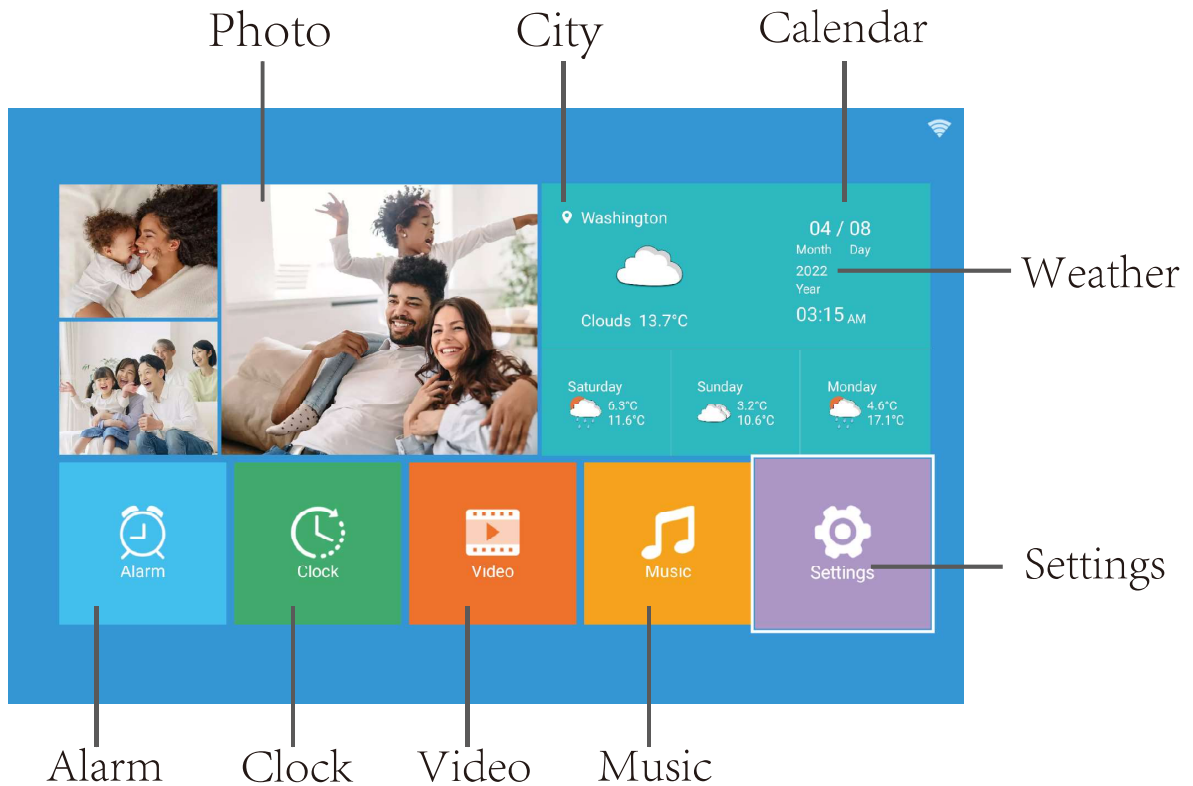

### 5.4 Photo

#### 5.4.1 Start Photo Slideshow

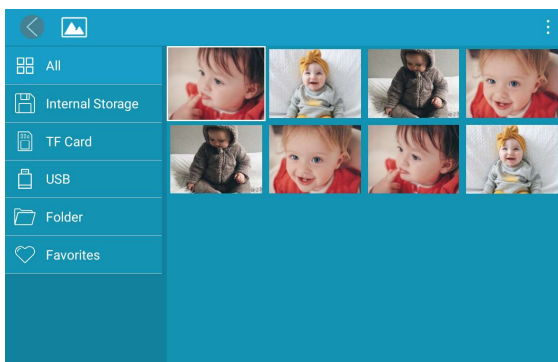

Select [Photo] on main menu to access to photo menu.

Choose photo from internal storage, SD card, USB, favorites or from user.

Select photo to start slideshow.

#### 5.4.2 Turn on/off Background Music

If you want to slideshow with background music, please Select [Music] in main menu, and select the music you want to play. Go back to [photo] to slideshow photo.





If you want to turn off the background music, please Select the slideshow photo and then Select the settings icon .

You can see a menu with the "Background Music" option, Select to choose turn on/ off the background music.

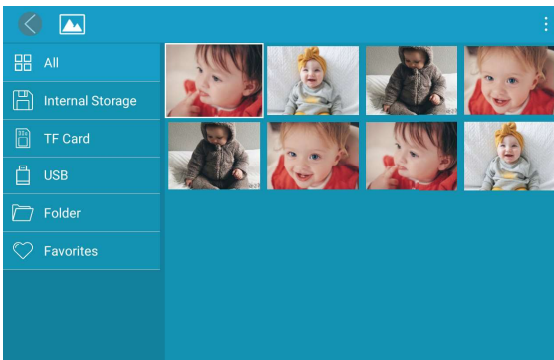
### 5.4.3 Delete Photo





Find the photo under All, Internal Storage, SD Card, USB, or Favorites, select the  on the top right. Then choose the picture you want to copy or delete. Or select the  to select all.

Select delete icon  to delete the photos. Select [OK] to confirm deletion.

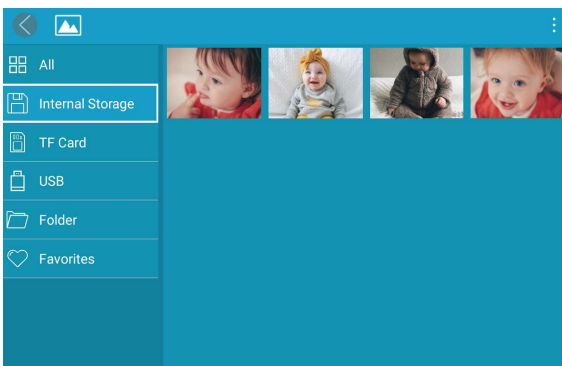
### 5.4.4 Copy Photo



Find the photo under All, Internal Storage, SD Card, USB or Favorites, Select  on the top right. Then choose the picture you want to copy or delete. Or Select icon  to select all.

Select copy icon  to copy the photo. Select destination and Select [OK] to confirm.

### 5.4.5 Add to or Remove from Favorites



While playing photo from the Internal Storage, Select the photo to show the option menu, select  icon to add or remove this picture to favorite.

**Tips:**

- Only the photos in the Internal Storage can be added as Favorites.
- Please copy the photos in USB or SD card to Internal Storage and then add them as Favorites if necessary.

**5.4.6 Rotate Photo**

While playing photo, Select the photo to show the option menu, select  to rotate the current photo 90 degree.

**5.4.7 Display in Multi-Windows**

While playing photo, Select the photo to show the option menu, select  to change the number of windows or in automatic split by system.

**5.4.7 Turn on/off Caption**

While playing photo, Select the photo to show the option menu, select  and select on/off Caption display.

**5.4.9 Adjust Slideshow Time Interval**

While playing photo, Select the photo to show the option menu, select  and Select Slideshow Interval to adjust.

**5.4.10 Adjust Slideshow Transition Effect**

While playing photo, Select the photo to show the option menu, select  and Select Slideshow Transition Effect to adjust.

## 5.5 Video

### 5.5.1 Play Video

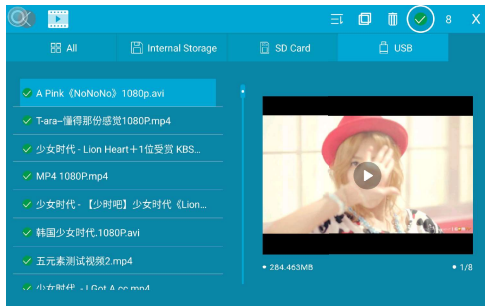



Select [Video] on main menu to access to video interface.

Choose video under All, Internal Storage, SD Card, or USB, select the video to play.

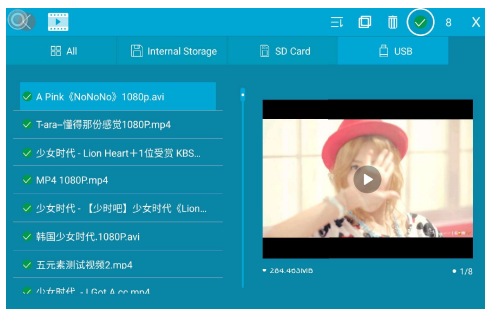
### 5.5.2 Delete Video





Find the video under All, Internal Storage, SD Card, USB, Favorites or from users, Select the  on the top right. Then choose the video you want to delete. Or select the  to select all.

Select delete icon  to delete the photos. Select [OK] to confirm deletion.

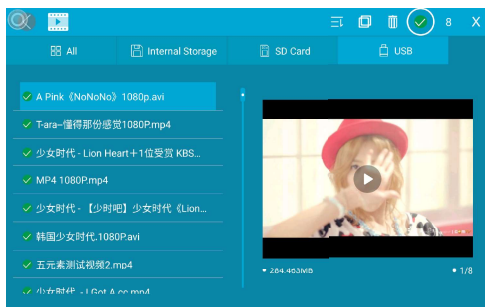
### 5.5.3 Copy Video



Find the photo under Internal Storage, SD Card, USB, or Favorites, Select  on the top right. Then choose the videos you want to copy. Or Select icon  to select all.

Select copy icon  to copy the videos. Select destination and Select [OK] to confirm.

## 5.6 Music

### 5.6.1 Play Music

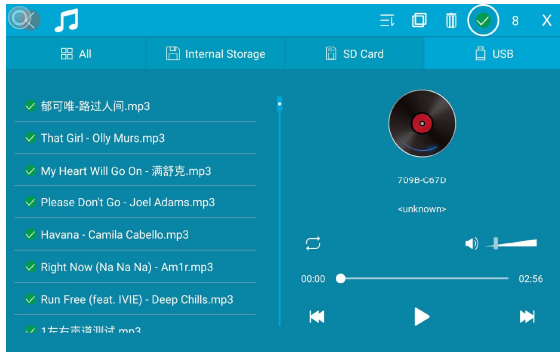



Select [Music] on main menu to access to music interface.

Choose music under All, Internal Storage, SD Card, or USB, Select the music to play.

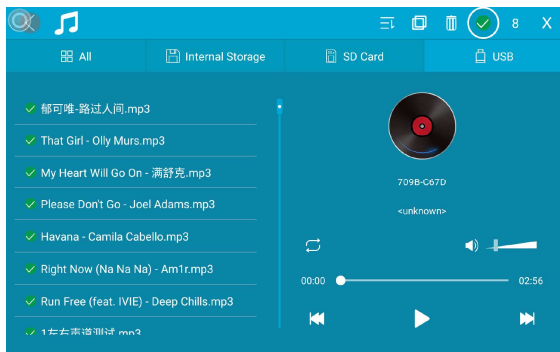
### 5.6.2 Delete Music





Find music under All, Internal Storage, SD Card, USB, Favorites or from users, Select the  on the top right. Then choose the music you want to delete. Or select  to select all.

Select delete icon  to delete the music. Select [OK] to confirm deletion.

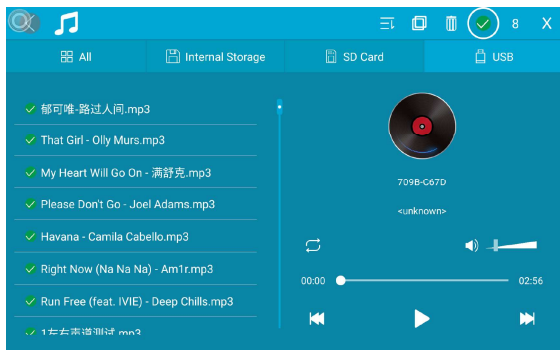
### 5.6.3 Copy Music



Find music under Internal Storage, SD Card, USB, or Favorites, Select  on the top right. Then choose the music you want to copy. Or select icon  to select all.

Select copy icon  to copy the music. Select destination and Select [OK] to confirm.

## 5.7 Calendar

Select the Calendar under main menu to view or adjust calendar.

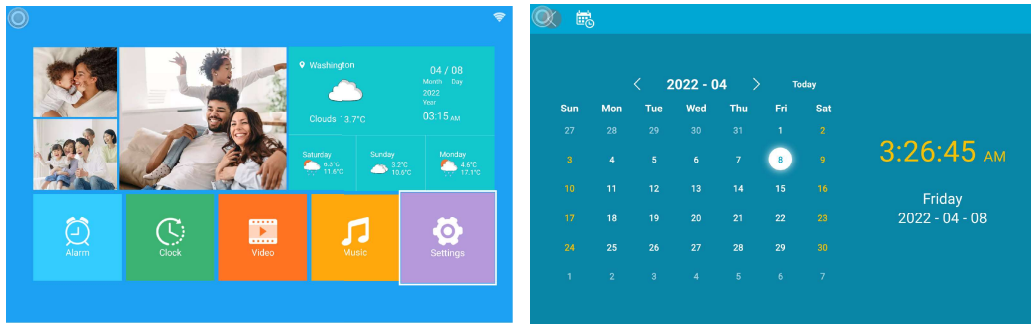

## 5.8 Clock

Select Clock function on main menu, scroll right or left to change the appearance of clock.

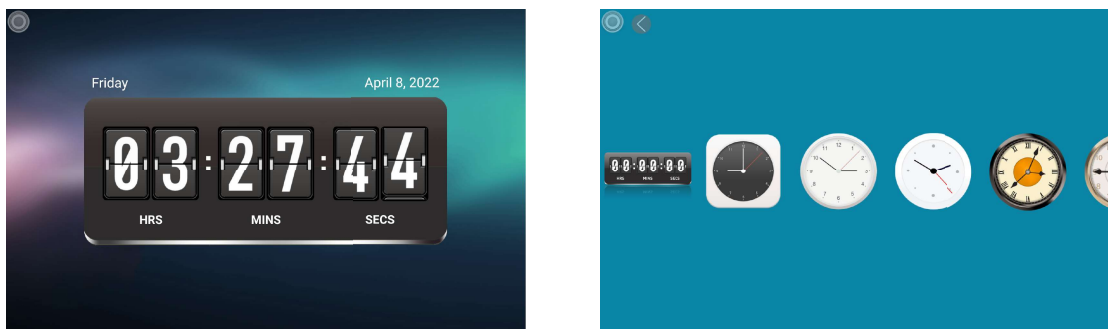

## 5.9 Alarm

Select [Alarm] on main menu to access to alarm interface.

Select [Add] to add new alarm.

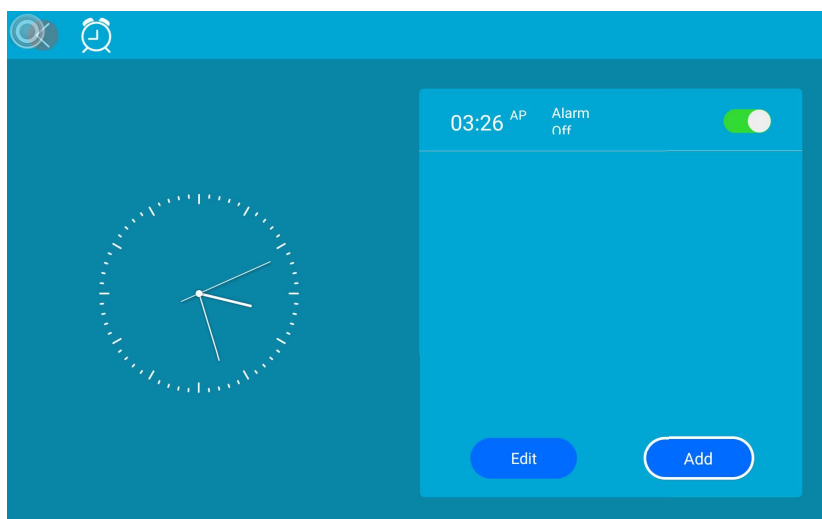

Select [Edit] to edit or delete alarm.

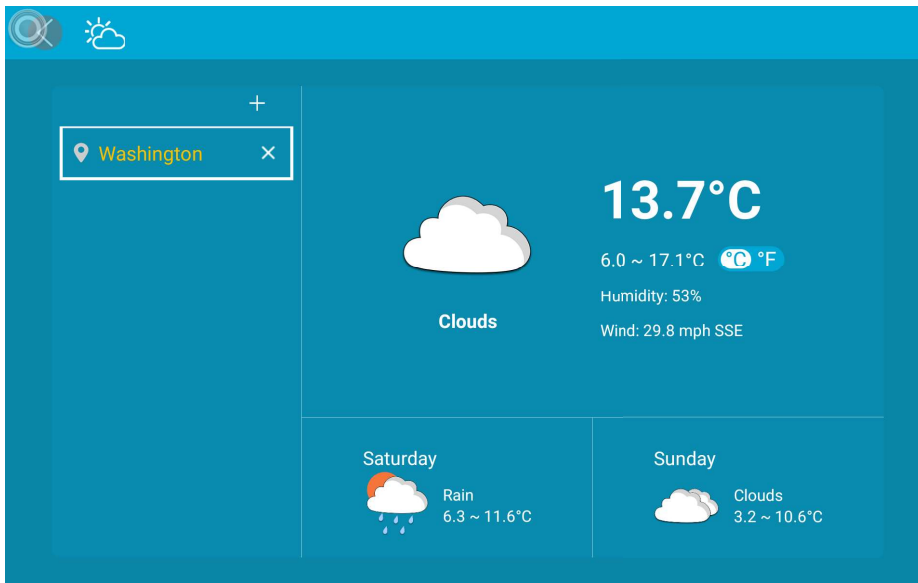

## 5.10 Weather

Select [Weather] on main menu to access to weather interface.  
Select [°C] or [°F] to switch temperature format.



Select  you can switch the city. Select + to add a new city. Select city, key in city name then Select  to search city.

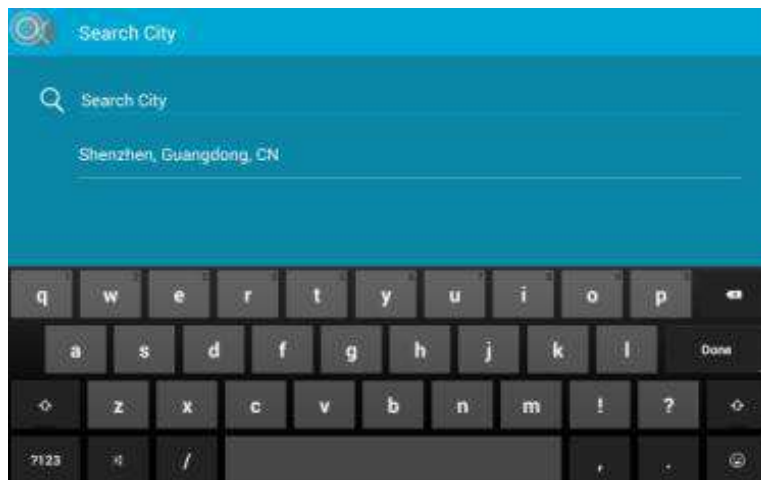



## 5.11 Settings

Select the settings icon  on main menu to enter settings interface.

### 5.11.1 My Frame

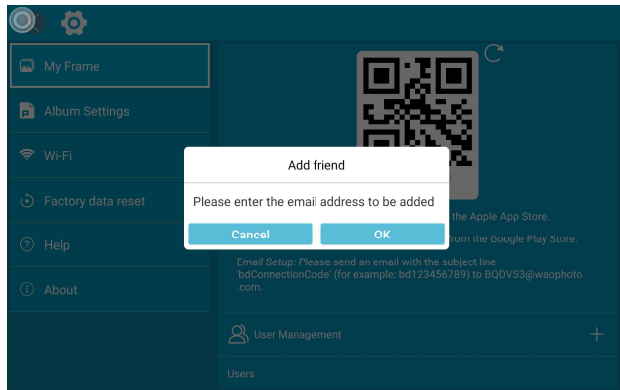
You can check the Connection code and QR Code in [My Frame] and manage users that are bound to this digital photo frame.



Select  to get the latest connection code and QR code. They are refreshed every 12 hours. Please connect to Wi-Fi network and select  to get the latest ones.

Select [User Management] to add new users.

Select name of the user to edit user, delete the photos/videos received from the user.

### 5.11.2 Album Settings

Menu	Setting	Remark
Volume Adjustment		Adjust the volume of speaker
Boot Direction	Vertical Display or Horizontal Display	Control the default display direction

Menu	Setting	Remark
Remote Control Sounds	On/Off	Set the sound of remote control
Language	English and more	Set the language
Slideshow	1 minutes to 24 hours	Set the slide transition interval
Slideshow Mode	Sequential/Random	Set the slideshow order
Sort By	Time/Name	Order the photos by time or name
Caption	On/Off	Show the Caption of the photo or not
Date & Time		Set date and time
Sleep		Set Sleep mode, time and repeat pattern
Auto-Rotate Screen	On/Off	Set up the screen whether auto rotate
Notification Sound	On/Off	Set the sound of notification



### 5.11.3 Wi-Fi Settings

Digital photo frame will scan available Wi-Fi networks and list the networks it finds. If the network was connected to the digital photo frame before, digital photo frame will connect to the network automatically.

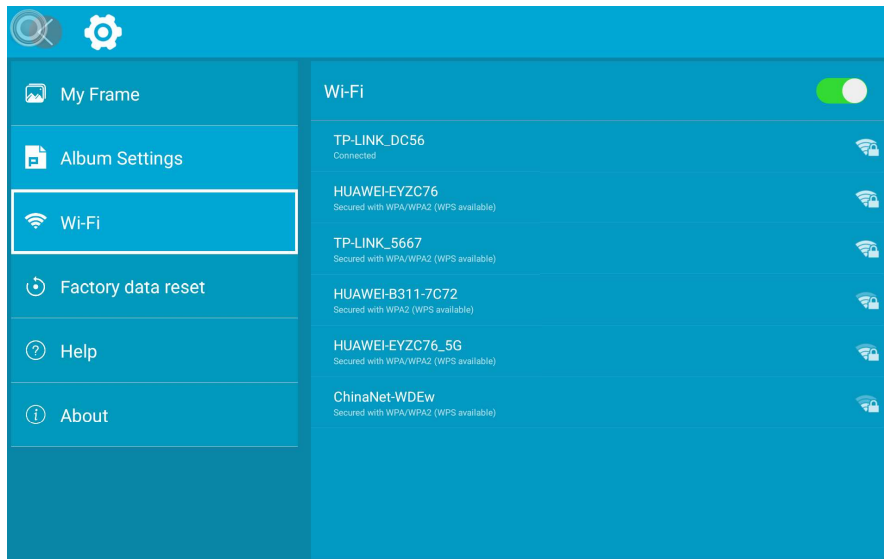

Select the network you want to connect to. Use the keyboard to enter the password. Check [Show password] to show password you entered.

Select [Connect] to connect Wi-Fi.

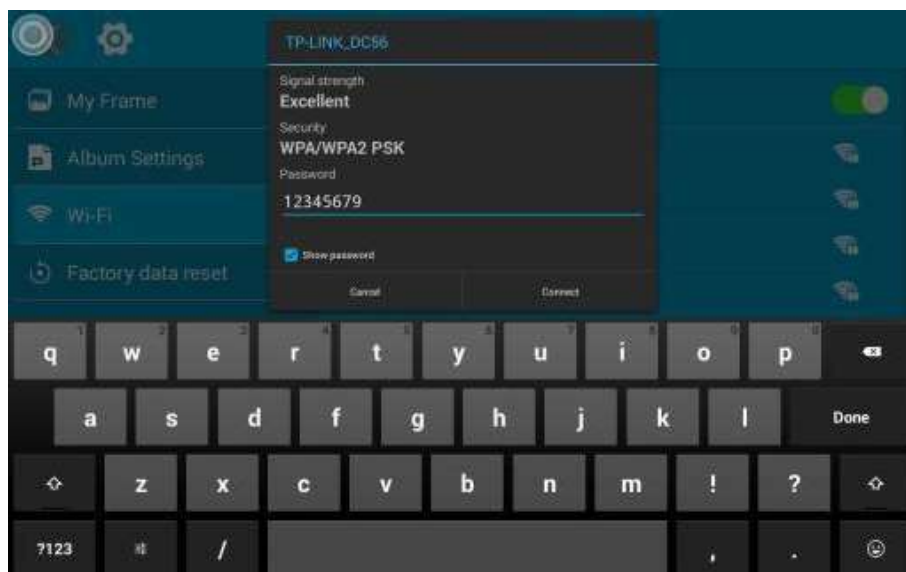

### 5.11.4 Factory Data Reset

In [Factory data reset], you can delete all the files in the internal storage and restore the digital photo frame to factory default settings.

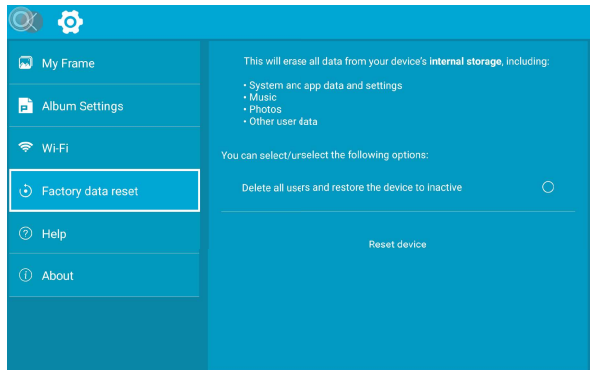

### 5.11.5 Help

In [Help] you can learn how to use the device. Please Scroll right or left for more information.

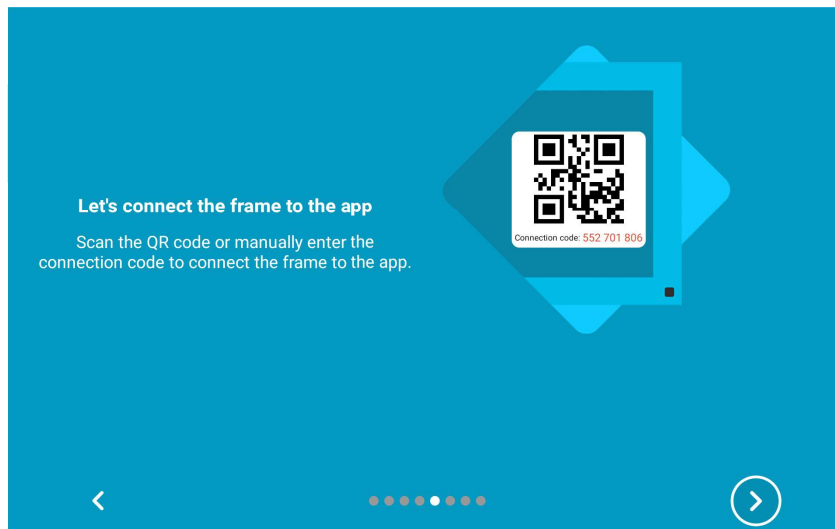

### 5.11.6 About

In [About] you can check firmware version, frame ID, internal storage and more.

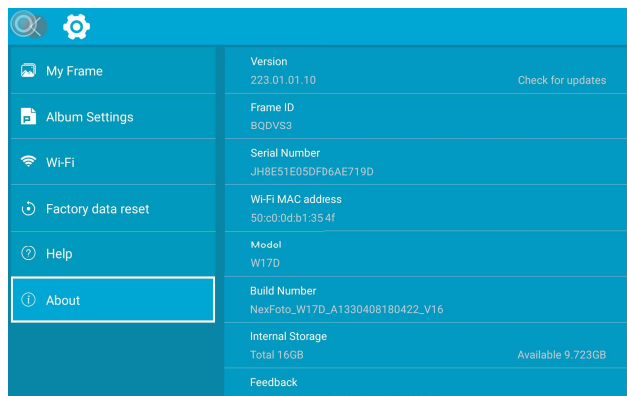

## Software Upgrade





When a new version of software is available, Select [Version] and you will see a pop up message [Find new version].

Select [Download] to download the new version of digital photo frame app.

After download is completed, Select [Install] to upgrade the frame app and Select [Cancel] to cancel the installation.

After installation, Select [Done] or [Open], the digital photo frame return to main menu interface.



Select  icon to go back to the previous menu. Select  icon to main menu.  Select to increase volume. Select  to decrease volume. Select  to power off the device.

## 5.12 Connect DPF with Computer

Please connect the digital photo frame with the computer via USB cable (USB cable is not provided)

On the computer, device PF2105WV will appear on computer. Internal storage is the memory of digital photo frame.

Please delete the files with carefulness to avoid damage the system files of the digital photo frame.

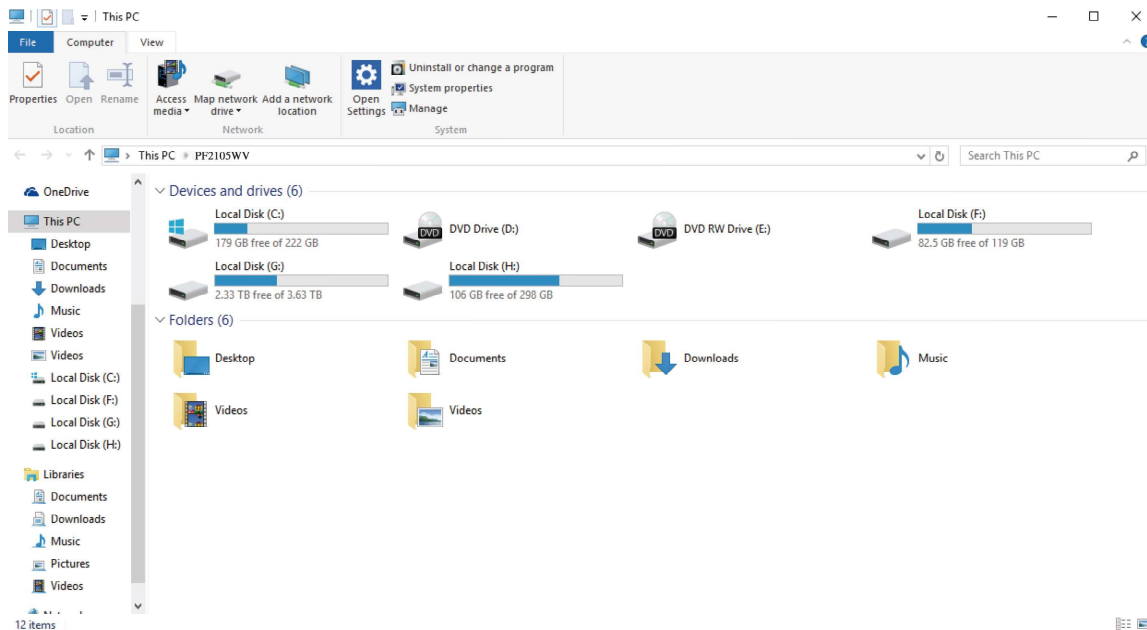

## 6 Privacy

QPIX Pty Ltd (“Company” or “QPIX” or “We”) takes the great honor providing products and services to our clients. We take the privacy of our customers seriously and are committed to protecting the information we collected. Our customers are entitled to understand how personal information will be collected, used, disclosed, and deleted.

This policy is our commitment and guide in daily operation. It is written with the best knowledge we have for an easy understanding by our clients.

Personal information under this policy refers to the information that identifies you, such as your name, email address or billing information, or other data that can be reasonably used to infer this information, whether sensitive or not.

As an important and useful feature, Wi-Fi digital photo frame may share photo and video via third party app. We select third parties and their app carefully with our deep concern of our customer's privacy and our high standards. The third-party app uses automated devices and applications to transfer data between mobile, server and digital photo frame. The shared photo and video are never collected or seen by QPIX or third parties. Communication between app and frame is end-to-end encrypted. Files stored on the server if there is any will be automatically destroyed 30 days later.

Please contact us if there is any concern regarding our adherence to applicable law and your personal information.

This privacy policy may change from time to time. We will update it on the company website.

## 7 Frequently Asked Questions (FAQ)

How can I hide the Assistive Touch Icon?

Select the settings icon  on main menu to enter settings interface. Select Album Settings, then Select Assistive Touch and change the settings to off.

Why are some photos loaded faster than others?

Higher resolution photos are loaded slower. Using a lower resolution when taking photos will speed up loading time.

I have a SD card or USB in the Digital Photo Frame, but it's not reading the card. What should I do?

First, make sure that you are using SD card or USB that is supported by the Digital Photo Frame. The maximum size of the SD card or USB is 32G.

Second, ensure that the SD card or USB is inserted all the way into the correct slot.

Please check the format of SD card or USB and format it if necessary.

While some files are not able to be played correctly?

Please check the format of the file as well as the software of the digital photo frame.

Please contact QPIX if the problem could not be fixed via software upgrade.

## **8 Customer Support**

Many questions regarding the operation of your QPIX product can be answered by reading the instruction manual packaged with this product.

If this product is deemed to be defective and is under warranty, you may return the product to the following address for repair or replacement. For support / technical assistance, contact us at,

QPIX PTY LTD

Unit 10, 573 Burwood Highway  
Knoxfield, Victoria, Australia, 3180

Email: [qpix@qpix.com.au](mailto:qpix@qpix.com.au)

## 9 Product Specifications

LCD Type	21.5" paper-feel IPS HD
Backlight Type	LED
Screen Resolution	1920 * 1080 pixels
Aspect Ratio	16:9
Brightness	200 cd/m <sup>2</sup>
Contrast	400:1
Viewing Angle	175° (left/right/vertical/horizontal)
Response Time	20 ms
Photo Format	JPG, JPEG, BMP, PNG and more
Music Format	MP3, WMA, WAV, OGG, APE, FLAC and more
Video Format	MPEG1, MPEG2, MPEG4 (Xvid/AVI), M-JPEG and more
Video Frequency	Support up to 30 frame per second (fps)
Media Slots	SD (SDHC/MMC) memory card up to 32 GB USB memory stick up to 32 GB
Clock/Calendar/Weather	Yes
Power Supply Input	AC100~240V 50/60 HZ
Power Supply Output	DC 5V 2A
Working Temperature	0°C~40°C
Humidity	10 - 85%



## 10 **Limited Warranty**

Your QPIX product is warranted to be free from defects in materials or workmanship under normal use for 1 year starting on your date of purchase. Your dated sales or delivery receipt is your proof of purchase. You may be required to provide proof of purchase as a condition of receiving warranty service.

During the warranty period, if a defective QPIX product covered by this Limited Warranty is returned to the QPIX service center, it will be repaired or replaced. If your QPIX product has recurring failures, at the option of the service center, you will be furnished with a different product that is equivalent in performance.

When permitted by local law, QPIX products and any replacement products or parts may contain new materials or used materials equivalent to new in performance and reliability. Replacement products or parts will have functionality at least equal to that of the product or part being replaced. Replacement products and parts are warranted to be free from defect in materials or workmanship for 90 days, or for the remainder of the warranty period for the QPIX product which they are replacing or in which they are installed, whichever is longer.

### **Exclusions**

This Limited Warranty does not cover cosmetic damage, loss or damage in transit, or damage resulting from (a) accident, misuse, abuse or other external causes; (b) product elements not supplied by QPIX; (c) modification or service by anyone other than QPIX, an QPIX service center or another QPIX-authorized service provider.